



NLI Fujioka Factory has adopted ISO 9001 to be certified its quality control technology for Industrial Sewing Machine and relative products.

# PORTABLE BAG CLOSER

## NP-3 II

## NP-7A

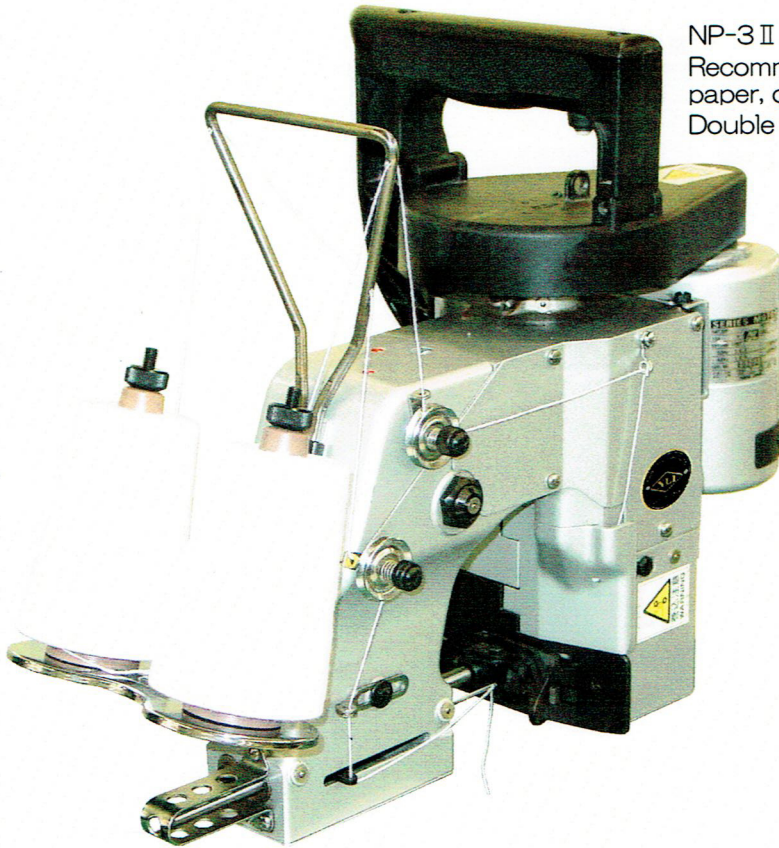

NP-3 II

Recommended for bags of all materials, like jute, paper, cotton, PP, etc.

Double thread chain stitch ensures tightest closure.

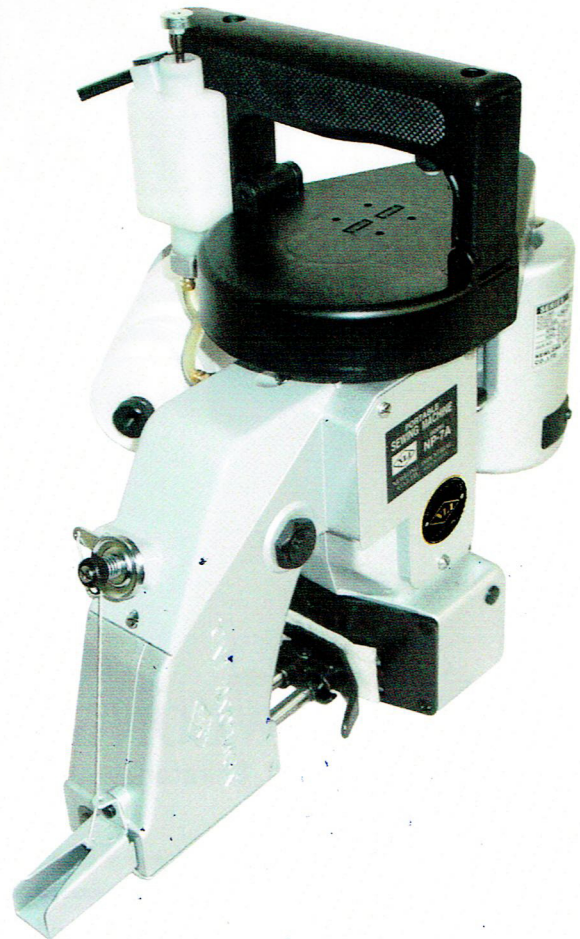

NP-7A

For minimum cost closing of all kinds of bags. Single thread chain stitch, with simple mechanism for easier maintenance. New type NP-7A is provided with a plastic handle and an auto-lubrication.



# NP-3II

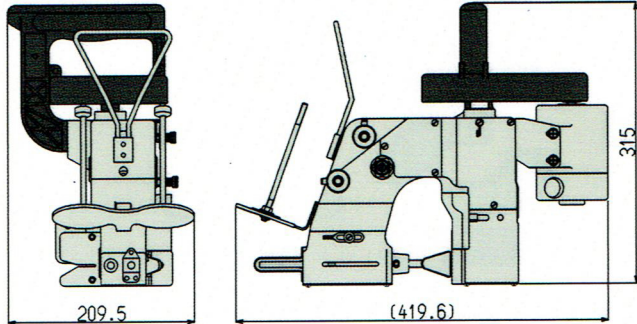
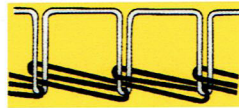

■ SPECIFICATIONS

Model	NP-3II
Capacity (rpm)	1,550 rpm
Stitch Range (mm)	8.5 (Fixed)
Seam	Double thread chain stitch
Thread Cutting	Automatic
Drive Motor (w)	90,1Ph (specity voltage)
Net Weight (kg)	6.0 (14lbs) with thread
Gross Weight (kg)	Approx. 9
Measurement (cft)	Approx. 2.5

# NP-7A

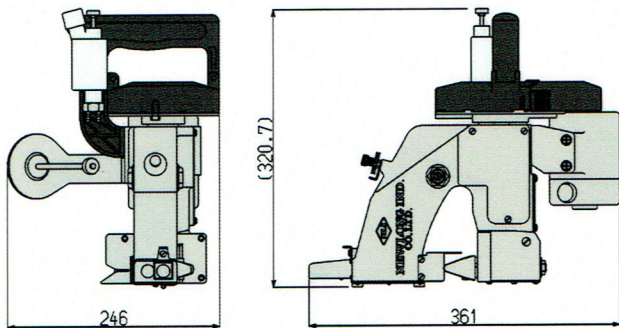
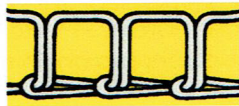

■ SPECIFICATIONS

Model	NP-7A
Capacity (rpm)	1,900 rpm
Stitch Range (mm)	8.5 (Fixed)
Seam	Single Thread Chain Stitch
Thread Cutting	Automatic
Drive Motor (w)	90,1Ph (specity voltage)
Net Weight (kg)	5 (13lbs) with thread
Gross Weight (kg)	Approx. 8.7
Measurement (cft)	Approx. 2.5

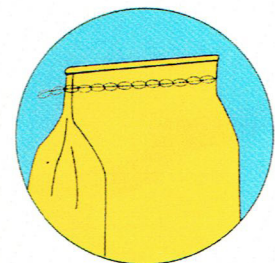

## NEWLONG INDUSTRIAL CO., LTD.

8-14, Shiratori 4-chome, Katsushika-ku, Tokyo 125-0063, Japan

Tokyo Head Office

PHONE +81-3-3603-2276

FAX +81-3-3603-2253

Mechanical Design Engineering Dept

PHONE +81-3-3603-2252

FAX +81-3-3602-2694